



Tractors

XERION

5000 4500 4000



# Firmly established. XERION.

We believe that size is everything, provided that it can also do everything.

The XERION large tractor is a perfect example of this, delivering an impressive engine output of up to 524 hp which it uses extremely efficiently thanks to a range of intelligent systems. Four driven, equal-sized wheels reliably transfer this power to the ground.





<b>CMATIC</b>	<b>6</b>
<b>The TRAC concept</b>	<b>8</b>
TRAC	12
TRAC VC	14
<b>CLAAS POWER SYSTEMS</b>	<b>16</b>
Engine	18
Transmission	20
Construction	22
Ballasting	24
Rear linkage	26
Hitches	28
PTO	30
Front linkage	32
Hydraulics	34
<b>Comfort</b>	<b>36</b>
Cab	38
Control panel	40
CMOTION multifunction control lever	42
CEBIS on-board information system	44
<b>Operator assistance systems and data management</b>	<b>46</b>
ISOBUS, terminal	48
Steering systems	50
Data management	52
<b>Service</b>	<b>54</b>
Maintenance	56
CLAAS Service & Parts	58
<b>The XERION at a glance</b>	<b>60</b>
<b>Features</b>	<b>62</b>
<b>Technical data</b>	<b>63</b>

Large tractors from 232 to 524 hp.  
CMATIC.



Made for real work.

CLAAS large tractors have become an established force in the tractor sector. The XERION and the two AXION model ranges offer the perfect solution for any type of hard work.

- Powerful and versatile 6-cylinder engines
- Spacious, comfortable cabs
- Ergonomic control concept

## Still unique.

Wherever high work rates, productivity and efficiency are required, the XERION provides the perfect solution.

The XERION is defined by a number of unique features:

- Four equal-sized wheels on two steered axles
- Full frame construction for heavy loads
- Continuously variable drive train delivering over 500 hp
- Intuitive, ergonomic controls



# Key benefits. The XERION family.



## Four equal-sized wheels on two steered axles.

The most striking feature of all the variants are the four equal-sized wheels on two steered axles. This creates a large contact area with the ground for optimum conversion of tractive force into pulling power. Two steered axles make it possible to configure different steering modes tailored to a huge range of applications.

## Full frame construction for heavy loads.

The XERION has a full support frame. The engine and transmission are separately mounted on silent blocks to minimise vibration, and the large cross beams ensure greater frame stability. The result is very high load capacities of up to 15 t per axle.

## Continuously variable drive train delivering over 500 hp.

The impressive output of the Perkins engines is transferred to the axles by the continuously variable ZF Ecom transmission. A high mechanical component in the transmission allows economical, fuel-efficient operation.

## Intuitive, ergonomic controls.

The intuitive CLAAS operating concept combining the CEBIS on-board information system and CMOTION multifunction control lever is unique. It allows the driver to control the main functions directly while keeping the arm and hand in a relaxed position on the armrest throughout.

## With a fixed cab. The TRAC.

For arable farming.

On the TRAC the cab is fixed in the middle of the vehicle. Its large windows offer excellent all-round visibility. Both the front and rear implement areas are in full view.

The TRAC is the perfect model for arable work such as tillage, drilling, field transport and slurry spreading.

Four equal-sized wheels provide excellent tractive power – and they're gentle on the soil. For optimum soil protection, it's important for loads to be evenly distributed across the two driven axles. Clever ballasting and the 110 mm ball behind the cab for the swan neck hitch distribute loads evenly and guarantee good traction during operation.



# With a rotating cab. The TRAC VC.

## Wide range of applications.

Some applications require particularly good visibility to the rear of the tractor. A rotating cab is ideal for:

- Silo work (maize and grass)
- Wood chipping
- Mulching
- Snow blowing

At CLAAS, VC stands for Variable Cab. The rotating cab is the most convenient reverse-drive system imaginable. At the press of a button, the entire cab moves from its central position to the rear-facing position above the rear axle in seconds.

The controls rotate automatically with the cab, so all functions remain the same when operating in the rear position.

For comfortable road travel, the cab is centrally positioned between the axles. In the silage clamp, on the field, in the forest or in the mountains, the XERION with the cab rotated over the rear axle becomes a user-friendly self-propelled machine with a unique view of the job in hand.





## **CPS** | CLAAS POWER SYSTEMS

Our drive system: the perfect interplay between optimal components.

Your CLAAS machine is much more than the sum of its individual parts. Top performance is only possible when all parts are ideally matched and work together optimally.

In CLAAS POWER SYSTEMS (CPS), we have brought together top-quality components to create an intelligent drive system that sets new standards. Full engine output only when you need it. Drives that are suited to the way your machines are used. Fuel-saving technology which quickly pays off.



# Performance packaged. The engine.

## Full power.

The 6-cylinder in-line engines from Perkins meet emissions standard Stage IIIA (Tier 3). In addition to mature technology, they offer a wealth of impressive benefits:

- High torque even at low engine speeds
- Consistent torque over a wide engine speed range

## Powerful and fuel-efficient.

The 12.5 litre engine with charge-air cooling is famously robust and what's more, thanks to the one-piece bonnet, it's easily accessible.



		XERION 5000	XERION 4500	XERION 4000
Cylinders		6	6	6
Cubic capacity	l	12.5	12.5	12.5
Nominal engine speed	rpm	2000	2000	2000
Rated output (ECE R 120)	kW/hp	358/487	330/449	295/401
Max. output (ECE R 120)	kW/hp	385/524	355/483	317/431
Max. torque	Nm	2353	2203	1932

Power equals efficiency.  
The transmission.



#### Linear drive train.

The drive train is linear. This deliberate design feature ensures that engine power is transferred directly to the axles and PTO.

Selectable longitudinal and transverse differentials provide optimum power transfer when it's really needed.



#### CMATIC means continuously variable.

CMATIC is the name of the continuously variable transmission technology used in CLAAS tractors. In the XERION series a ZF Eccom transmission provides efficient conversion of engine power. Four multidisc clutches ensure that power transmission always includes a high mechanical component, making the XERION particularly efficient. The driving comfort with a continuously variable transmission is unique in this hp class.

#### ZF Eccom 5.0 transmission.

- Reversing speeds of up to 30 km/h
- Permanent four-wheel drive
- Available for top speeds of 40 and 50 km/h



# Unique. The construction.

## Single or dual wheels.

The two steering axles allow single wheels (four wheels) or dual wheels (eight wheels) to be used (TRAC and TRAC VC). One-piece or two-piece spacers can be bolted in place in order to fit dual wheels. The advantage of two-piece spacers is that they give a transport width of 3.0 m with 710 tyres when the dual wheels are removed.



## Firmly attached.

The two halves of the frame are connected by large tubular steel sections to further increase the strength and load-carrying capacity.



## High load-carrying capacity.

The 110 mm ball hitch behind the cab supports a maximum drawbar load of 15 tonnes. A swan neck attachment for mounted implements makes the tractor/implement combination highly manoeuvrable. The hitch ball absorbs the high loads and distributes them evenly across the entire vehicle.

## Long wheelbase.

The long wheelbase enhances driving comfort. But the 3.5 m spacing between the axles doesn't just improve operating stability – it also plays a major part in converting engine power into effective tractive power.

Two steering axles ensure that the XERION remains manoeuvrable and easy to handle.



# Perfect equilibrium. The ballasting.



Tractive power makes all the difference.

The four equal-sized wheels efficiently convert the installed engine power into equal shares of tractive power. Using the wheel slip display and rapidly adjustable engine droop, the driver can quickly find the optimum setting for every job.



Good distribution.

The tare weight is distributed optimally across both axles even without additional weights. A factory-fitted ballasting pack is also available which allows the tractor to be easily optimised for every task. 400 kg weights can be installed on the front weight and the rear plate and locked in place.



Front: fixed or variable.

CLAAS offers two different front weights: one is designed to be fixed permanently in place and one can be attached via the front hydraulic linkage. Both weigh 1,800 kg. Four additional weights can be added to increase the ballast to 3.6 t.



Rear: a range of options.

A 200 kg base plate can be mounted over the rear axle by means of a simple locking system. The ballast can be quickly increased to a total weight of 3.4 t by adding up to eight additional weights.

Simply lifts more.  
The rear linkage.



Continuous power.

The 3-point hitch on the rear linkage is fitted with category IV hitch points as standard.

- Double-acting rams
- Continuous 10 t lift capacity
- Vibration damping



The top link.

For the top attachment point on the 3-point hitch at the rear, CLAAS offers a mechanical top link with category IV (heavy duty) hitch points (1) or a hydraulic top link with category III or IV hitch points (2).



The lower link stabilisers.

You can choose between mechanical lower link stabilisers or inner stops. The mechanical lower link stabilisers (3) are easy to unlock by means of a chain and are threaded for continuous adjustment. The inner stops can be adjusted to give two different lower link positions.



The linkage can also be fitted with internal reinforcement to give category IV N (4). The lower links are then connected directly to the tow hitch support, making stabilisers superfluous.

## A strong attachment. The hitch points.



### Ladder hitch.

- Locks automatically into the drawbar when counterpressure is applied
- Drawbar load maximum 2,500 kg
- 38 mm pins
- Height-adjustable
- 80 mm ball head coupling, drawbar load 3.0 t at up to 40 km/h



### Swan neck.

The swan neck coupling has become an accepted method of attaching trailed slurry tankers. The 110 mm ball hitch behind the cab is designed to take a maximum drawbar load of 15 t, and the ball position immediately behind the cab distributes the drawbar load across both axles. Having the hitch directly behind the cab gives a smaller turning radius and a much shorter combination length than a tractor with a rear-mounted slurry tanker.



### Drawbar hitch.

Three holes in the drawbar hitch give you a choice of three positions. You can also choose between different attachment points.

- Drawbar with 40 or 50 mm diameter locking pin
- Drawbar with 80 mm hitch ball
- Drawbar with Piton Fix

A drawbar with a positive steering device is also available for positively steered implements.



Using the swan neck hitch for attaching a slurry tanker offers several benefits:

- Significant reduction in overall length
- More manoeuvrable at headlands
- Better axle load distribution reduces soil compaction

# Power where it's needed. The PTO.

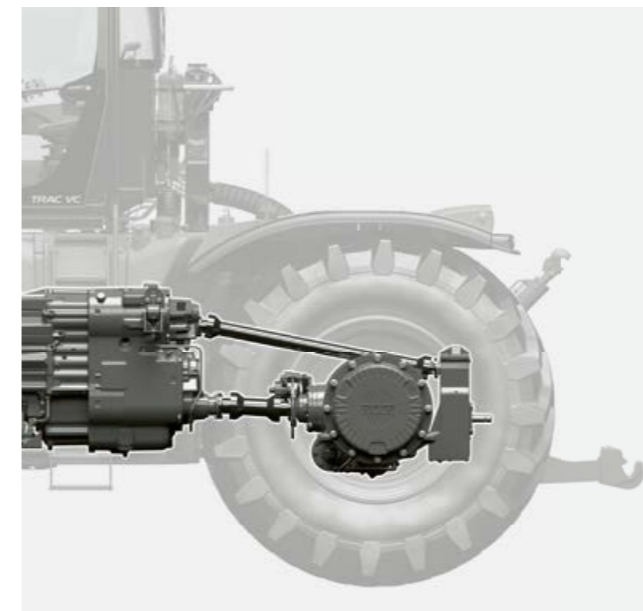

## Plenty of usable power.

When the PTO is running at 1,000 rpm, the XERION develops its output at a reduced engine speed of 1,730 rpm. Thanks to the simple drive train design, the full output is transferred to the PTO stub.

This enables you to reduce your fuel consumption while working at full engine output.



## Choice of PTO stubs.

- 1 3/4", 6 splines
- 1 3/4", 20 splines
- 2 1/4", 22 splines (Ø 57.7 mm)

With the 2 1/4" PTO stub, engine outputs above 500 hp are effectively transferred to attached implements.



The PTO can be switched on externally using the yellow push button on the mudguard. Inside the tractor there is a yellow emergency stop button for rapid PTO deactivation.





# Loves heavy work. The front linkage.



## Fully integrated.

The front linkage is fully integrated into the frame. The lower links fold in easily to reduce the vehicle length. Further benefits include:

- Robust design
- Continuous 8.1 t lift capacity
- Double-acting
- Position control
- Vibration damping

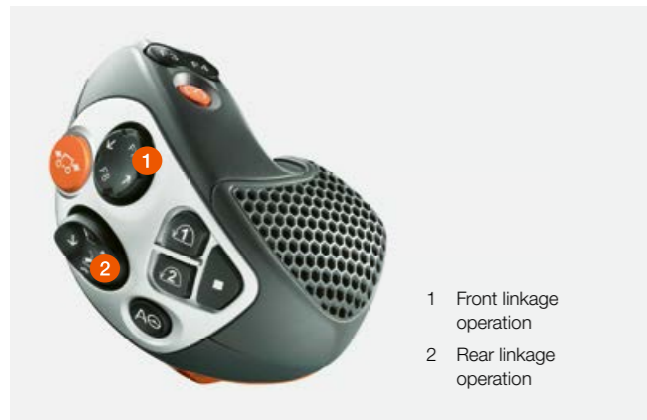

## Everything in hand.

easily with your thumb without having to move your hand.

- 1 Front linkage operation
- 2 Rear linkage operation



### Front linkage

- Working position for area calculation
- Lift height limiter
- Lowering speed
- Lifting speed

## Many options.

The front linkage is operated electronically. All settings can be adjusted quickly and easily on the CEBIS control terminal.



The front linkage and one spool valve are easily operated by push buttons at the front of the bonnet.

Keep up the pressure.  
The hydraulics.

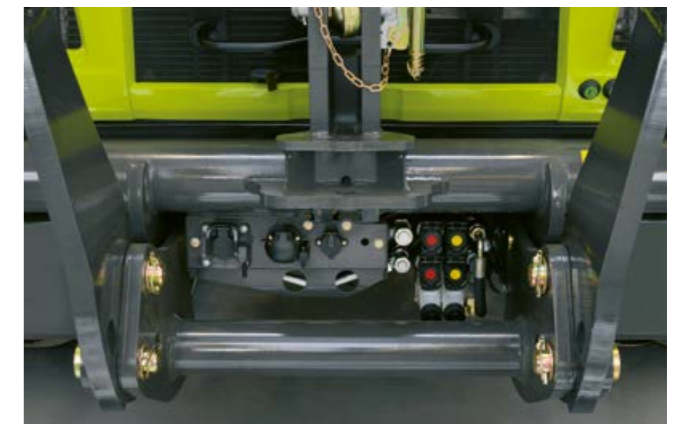

#### Connections at the front.

Up to three double-acting spool valves are available at the front of the XERION if there is no front linkage.

#### The facts.

The XERION is equipped with two hydraulic load-sensing circuits:

- 1 Primary circuit for the spool valves and linkages
- 2 Secondary circuit for oil cooling, steering and brakes

A third hydraulic circuit (optional) provides additional constant output of 86 l per minute (at 200 bar).

The performance figures for the primary circuit are:

- 200 bar operating pressure
- 205 l/min max. supply volume
- 105 l/min max. flow rate per spool valve
- 61 kW max. hydraulic output
- 120 l tank capacity



#### Connections at the rear.

Six double-acting spool valves are available at the rear when a linkage is fitted, and up to seven are available when specified without.

#### Power Beyond.

The Power Beyond connections with large-diameter lines and flat couplings at the front and rear provide a high oil delivery rate to attached implements with low losses.



Business class.

Exceptional visibility – large windows for a perfect all-round view. A superior, ergonomically designed workplace.

Full power at your fingertips. CEBIS optimises the settings, ensuring that this power is fully utilised. Intuitive 3-finger operation with the unique CMOTION multifunction control lever.



# Business class. The cab.



## Convenient reverse-drive system.

The cab on the XERION TRAC VC (Variable Cab) can be rotated through 180° in less than 30 seconds simply by pressing a button. This new position at the rear of the tractor gives the driver an excellent view of rear-mounted attachments. All the controls move as well – automatically. For tasks such as silo work, chipping wood, snow blowing or mulching, this convenience is unique.



## Magnificent view.

The spacious cab offers unbeatable all-round visibility thanks to its large windows and 4-pillar design. And long working days are no problem with a maximum noise level of 69 dB.



## Intelligent suspension.

Semi-active cab suspension enhances driving comfort in all applications. The electronically controlled dampers automatically adjust the suspension to the current driving situation.



## Lighting.

The XERION lighting system is based on two different voltage networks. The road lights are powered by a voltage of 12 V and the work lights by a 24 V system.

- Up to twelve work lights at the front
- Up to eight work lights at the rear



# Everything under control. The armrest.



## Control panel.

The control panel is equipped with additional function switches which are identified by self-explanatory symbols.

- 1 Speed range switch (road: max. 50 or 40 km/h, field: max. 30 km/h)
- 2 Pivoting rear linkage / Lock lower link stabilisers
- 3 Switch between using CMOTION to control the front linkage or to operate the white spool valve
- 4 Reversible fan
- 5 Parking brake / neutral
- 6 Activate longitudinal and transverse differential
- 7 Differential locks, manual or automatic
- 8 Engine-speed memory
- 9 Hydraulic spool valves
- 10 PTO
- 11 Power hydraulics (auxiliary drive)
- 12 Control rear linkage operating position
- 13 ELECTROPILOT (four-way control lever for two spool valves)
- 14 E-gas (manual engine speed adjustment)

## Ergonomic.

The armrest is designed to ensure that the driver's arm and hand remain relaxed and comfortable while controlling the most important functions. Even when operating the CMOTION multifunction control lever, your hand lies on the armrest and does not get tired.



## Adaptable.

You can adjust the entire armrest to suit your needs: use the two levers in the middle of the console to move it horizontally and vertically.



Everything in one place.  
The CMOTION multifunction control lever.



Within easy reach.

The CMOTION multifunction control lever from CLAAS is a unique concept which allows convenient and efficient operation of the main XERION functions. Eight individually

assignable function buttons for a wide range of implement and machine control options are located on the CMOTION multifunction control lever.

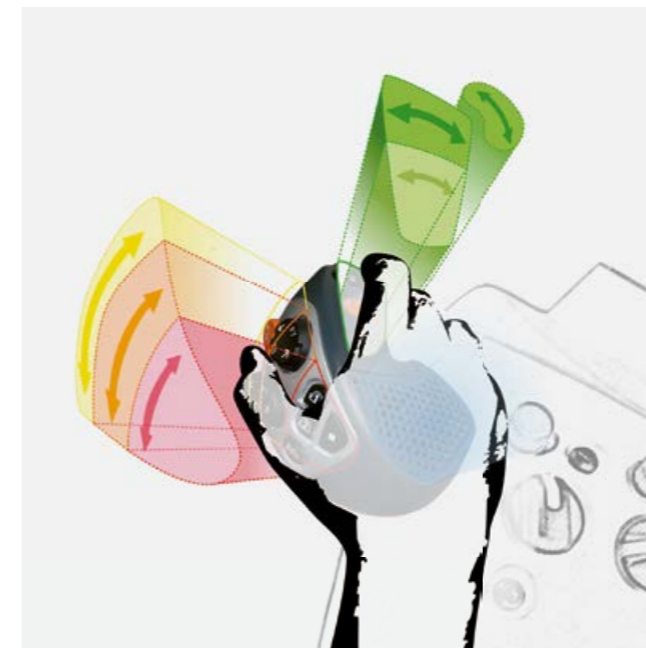

Pure ergonomics.

The CMOTION multifunction control lever allows you to control complex processes with up to four control functions without moving your hand from its ergonomic position on the lever. The functions are operated with the thumb and first two fingers, reducing fatigue in your hand throughout the working day.

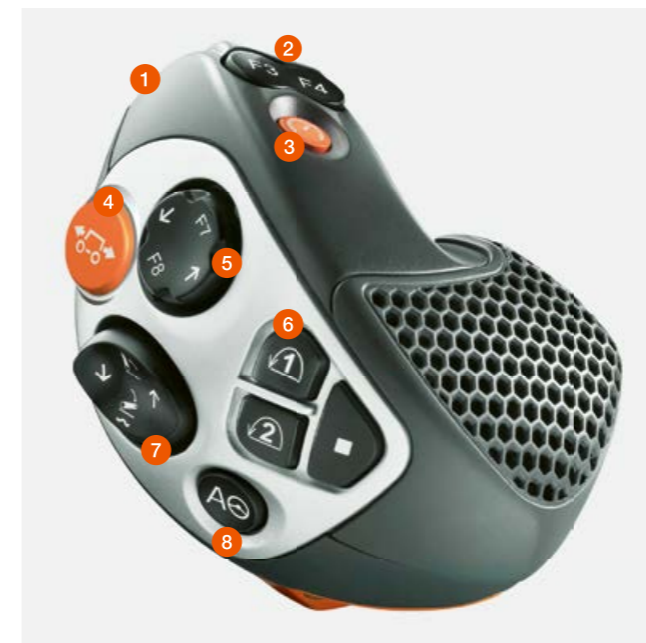

- 1 Function buttons (F5 / F6)
- 2 Function buttons (F3 / F4)
- 3 Cruise control
- 4 Start up / reverse
- 5 Front linkage / hydraulics; function buttons (F7 / F8)
- 6 CSM headland management; function buttons (F1 / F2)
- 7 Rear linkage
- 8 Steering system

# Everything under control. CEBIS.



Clear, simple, faster operation.

In working mode, the basic tractor settings are entered via the CEBIS rotary switch. An additional HOTKEY rotary/push switch provides rapid access to control other functions. The position of the rotary switch is shown on the CEBIS display.

An eye-catching 21 cm screen.

The 8.4" colour CEBIS screen can easily be positioned to provide the perfect view. A ball head mount allows the monitor to be adjusted exactly as the operator requires.

Always well-informed.

Information, control and monitoring are the tasks of the CEBIS electronic on-board information system. It features a clear and logical menu structure for easy navigation.

A quick look is all it takes: the CEBIS display gives you an overview of current processes and statuses. The screen summarises all relevant information clearly and concisely in both road view and work view mode. The operator is alerted to warnings by audible beeps as well as visual icons and text.

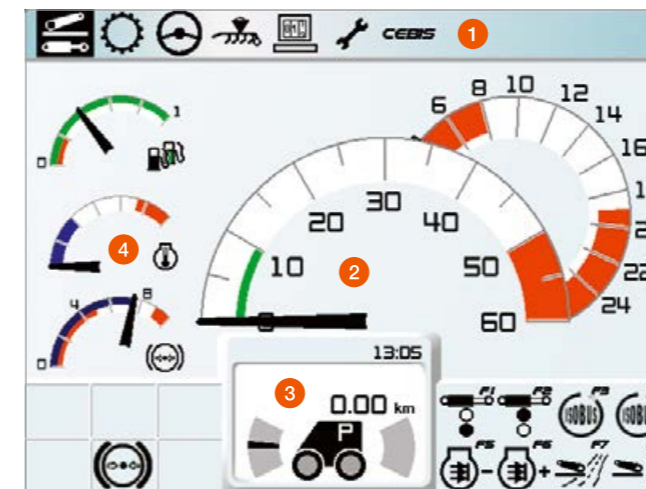

CEBIS colour screen.

- 1 Menu bar
- 2 Ground speed and rpm
- 3 Travel information
- 4 Fuel, temperature and air indicator

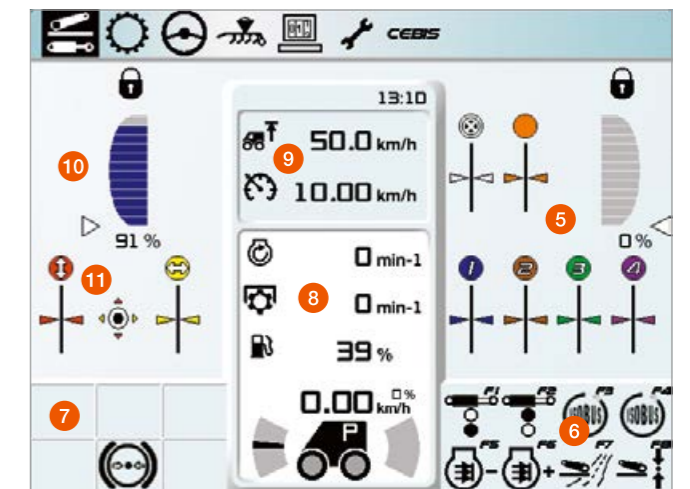

CEBIS operating screen.

- 5 Rear linkage / rear spool valve status
- 6 Function button assignment:  
F1 to F8 on the multifunction control lever
- 7 Message window
- 8 Configurable display area
- 9 Variable display area dependent on selected menu item
- 10 Front linkage status
- 11 Front spool valve status

# Steering systems and data management. On the right track.

When you are working in the field, every centimetre counts. Automatic steering systems play an important role in saving valuable resources such as consumables, time and money. We work with you to get your tractors on track to delivering valuable savings.

With the right choice of TELEMATICS licence, for example, which allows the transmission of machine data. And intelligent TELEMATICS modules such as CLAAS API, TONI and Data Connect which you can combine to suit your needs. Get the best out of your farm.

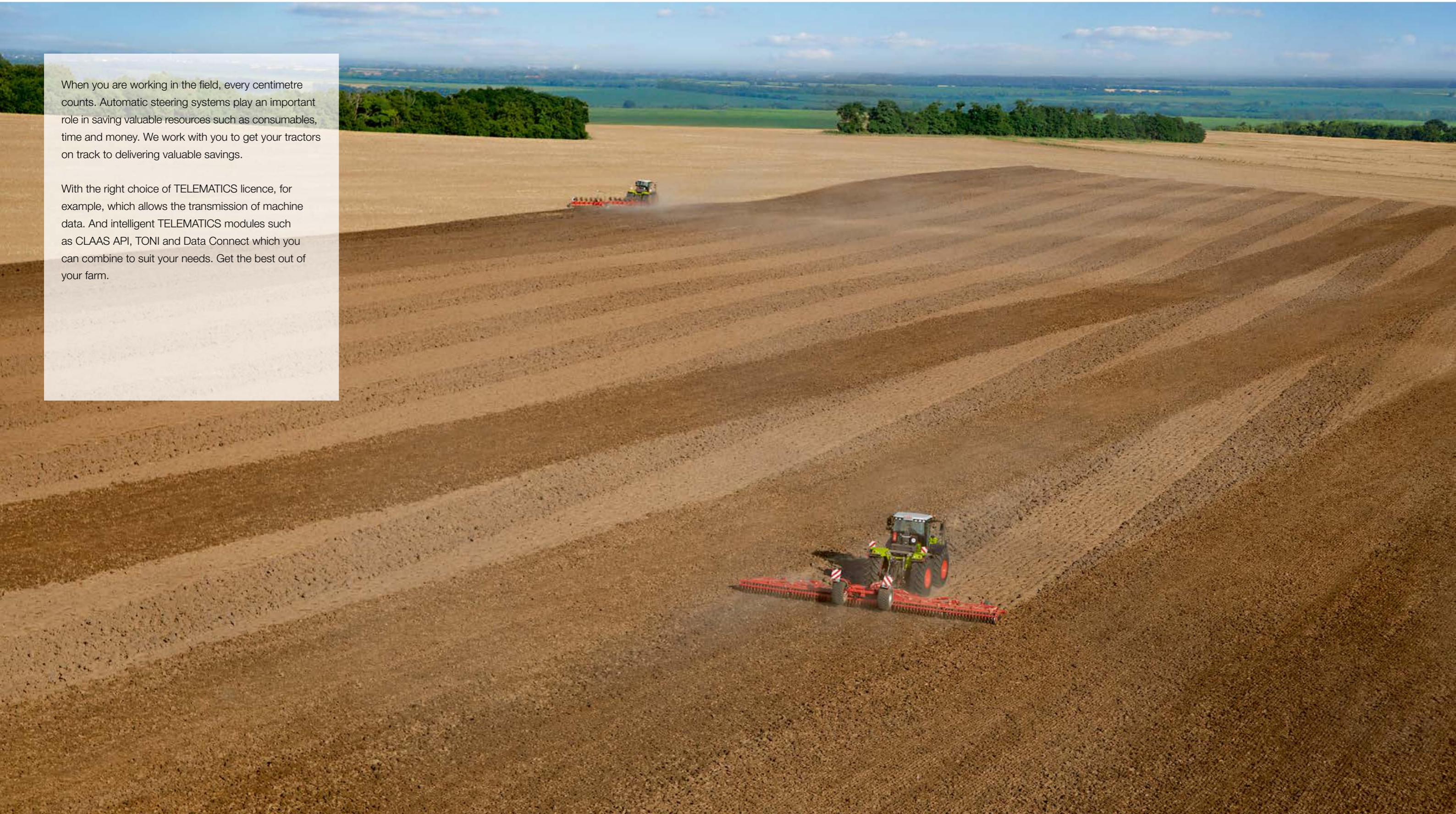



# S10 terminal. Control improves the quality of work.



## S10 for ISOBUS and steering systems.

- High-resolution, 10.4" colour touchscreen
- GPS steering system and ISOBUS terminal with ISO-UT, TC-GEO / TC-BAS / TC-SC
- Reference line management
- AUTOTURN automatic turning at the headland
- TURN IN line-up assistant

The S10 terminal is extremely versatile. You can operate the steering system while at the same time controlling ISOBUS implements and connecting up to four analogue cameras.

## Terminals optimise efficiency.

Our S10 terminal offers a flexible solution for using ISOBUS and steering systems. The self-explanatory terminal features a simple, logical layout designed for ease of use.

You can move it from the XERION to another tractor or a self-propelled harvester, depending on the season or job in hand.

## Intelligent machines reduce the driver's workload.

- High-resolution S10 terminal for ISOBUS and steering systems
- Precise, efficient working in all operating conditions

# Always on the right track. CLAAS steering systems.

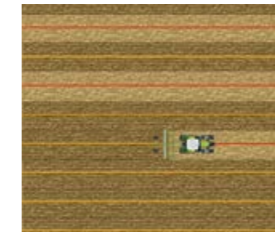

#### RTK NET (accuracy $\pm$ 2-3 cm)

- Correction signal via mobile phone network
- Unrestricted working radius

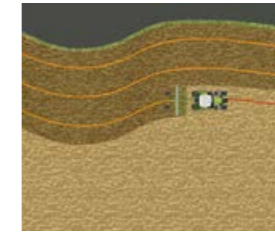

#### RTK FARM BASE LINK (accuracy $\pm$ 2-3 cm)

- Base station
- Station data transmitted via mobile phone network (NTRIP)
- Operating radius 30 km

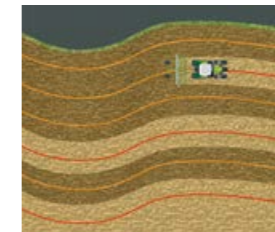

#### RTK FARM BASE (accuracy $\pm$ 2-3 cm)

- Base station with digital and analog radio can be used
- Range up to 15 km

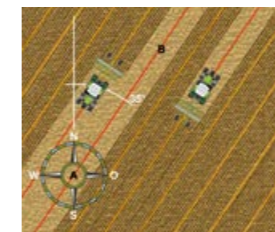

#### SATCOR

- Satellite-based correction signal from CLAAS
- Virtually worldwide coverage

##### SATCOR 15 (accuracy $\pm$ 15 cm)

- Improved basic accuracy
- Quick signal availability
- Good signal suitable for many applications from soil cultivation to harvesting

##### SATCOR 5 (accuracy $\pm$ 5 cm)

- Ideal in areas where RTK and mobile phone coverage is patchy
- Longer initialisation period than SATCOR 15 but more accurate

#### EGNOS / E-DIF (accuracy $\pm$ 30 cm)

- No licence fee
- Basic accuracy

## CLAAS steering systems increase work quality.

CLAAS steering systems take the pressure off the driver. They show in advance which direction to take, or automatically steer the tractor along the best possible path. Studies show that a modern parallel guidance system can save up to 7% on fuel, machine costs, fertiliser and crop protection products by eliminating mistakes and overlaps.

### GPS PILOT with high steering precision.

The satellite-based automatic steering system from CLAAS is fully integrated into the machine. It takes the hassle out of any job which depends on high pass-to-pass accuracy.

You start the GPS PILOT via the multifunction lever. It actively controls the steering hydraulics and guides you across the field precisely at all speeds, regardless of the light conditions. It works at night or in low visibility just as precisely as it does in full daylight. You receive correction signals for whichever degree of accuracy you require.

The GPS PILOT automatic steering system is controlled by the S10 touchscreen terminal (see pages 48 / 49) which features a very simple and user-friendly menu-guided interface.

### Automatic steering at the headland.

The AUTO TURN function takes care of turning manoeuvres at the headland. The driver preselects the direction of the turn and the next track to be worked on the S10 terminal. The steering system does the rest.

### Flexible options for correction signals.

We have designed our range so that you can extend your system easily at any time. This applies just as much to the terminal technology as to the use of all major correction signals. We can now work with all available satellite systems – GPS, GLONASS, BEIDOU and Galileo



With AUTO TURN the tractor turns automatically at the headland.

# A connected XERION is more productive.

## Digitalisation pays.

Digitalisation is a key factor in increasing your productivity and efficiency. Data generated in completely different places can be collected and evaluated centrally. This conserves your resources and improves your business processes.

To enable you to get more out of the XERION and your other machines, CLAAS offers a range of modules which allow systems, technology and working processes to be connected with each other, regardless of the manufacturer. Intelligent digitalisation matched to the requirements of your farm can reduce your workload significantly.

- Transfer and document machine and job data quickly
- Manage individual machines and the whole fleet efficiently
- Analyse working processes carefully and optimise them
- Analyse fields easily and map yields precisely
- Call up and manage farm data with intelligent farm management software
- Transmit data from different manufacturers' machines to TELEMATICS smoothly
- Save valuable maintenance and service time with remote diagnostics

## TELEMATICS records your success.

With TELEMATICS you can continuously retrieve and record work and performance data for your tractor. All data are transmitted via the mobile phone network from the machine to the server, where they are processed and stored. You can access and evaluate your data online in real time or retrospectively via the web portal or the TELEMATICS app. The Connected Documentation licence amalgamates all the data on a field-specific basis in the background. It is also possible to export your data to any current farm management software program.

## CLAAS API connects your office to your fleet.

With the DataConnect function, CLAAS, 365FarmNet, John Deere, Case, Steyr and New Holland have created a direct, multi-manufacturer, industry-wide and open cloud-to-cloud solution. This allows you to control and monitor your entire machinery fleet in the CLAAS TELEMATICS portal – safe in the knowledge that all relevant data are exchanged securely, conveniently and fully automatically. Both systems are components of CLAAS TELEMATICS.

## Remote Service costs you nothing.

Remote Service from CLAAS is an important machine networking element which greatly simplifies maintenance and service support.

The machine informs the service partner of an upcoming maintenance requirement or notifies them immediately if a fault arises. The service partner has access to the relevant data, so they are ideally prepared to intervene in both scenarios. CLAAS covers the cost of Remote Service for you during the first five years. All you have to do is give your consent.

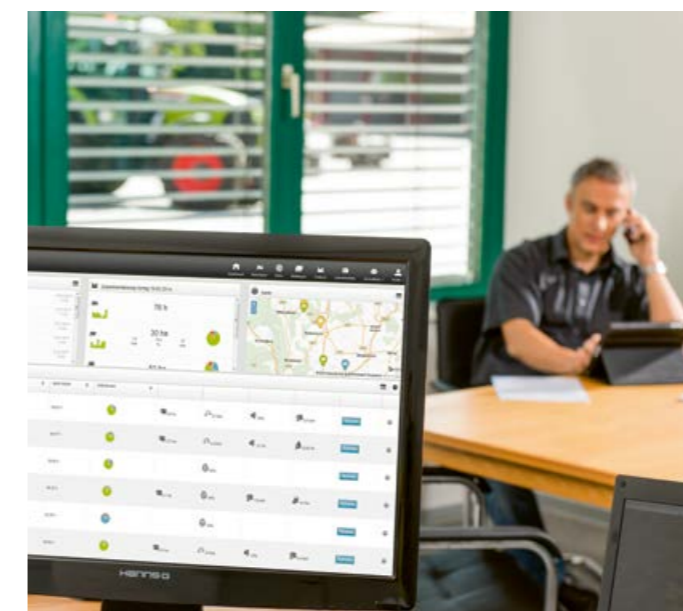
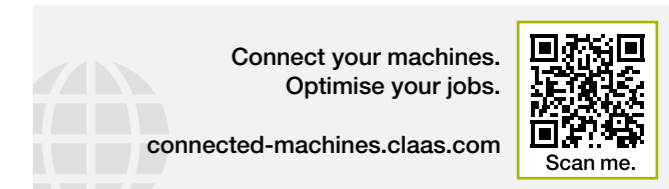

## Digitalisation puts your farm ahead.

- TELEMATICS transfers your data from your machine straight to the cloud
- DataConnect allows you to process data from your machines, regardless of manufacturer
- Remote Service simplifies maintenance and service support

Always ready for action.  
Maintenance and service.

# XERION

The XERION never lets you down.

Maintenance, spare parts, service: the CLAAS team does everything it can to minimise downtime. We have developed clever solutions for effective maintenance – and a well-prepared machine provides maximum operational reliability. Ensuring that your machine functions correctly and retains its value are our top priorities. Because we know that your tractor is key to your success.



# Very fast. Maintenance.

## Hassle-free servicing.

The XERION is highly impressive when it comes to its minimal maintenance requirements. For example, the service interval for transmission, hydraulic and axle oils is 1,500 hours.

When maintenance does become due, it can be carried out quickly and effortlessly. The engine oil filter is positioned within the full frame for easy access.

## More time in the field.

- Oil-change interval for transmission, hydraulic and axle oil: 1,500 hours
- Easy access to the engine oil filter.
- The one-piece bonnet provides easy access to all service points
- A new engine air intake system increases the service life of the filter cartridge considerably
- The service status is shown on the CEBIS display
- Robust, easily accessible battery compartment
- Easy access to coolant reservoir

These features combine to make daily service and maintenance tasks much easier, helping to preserve the value of your machine.

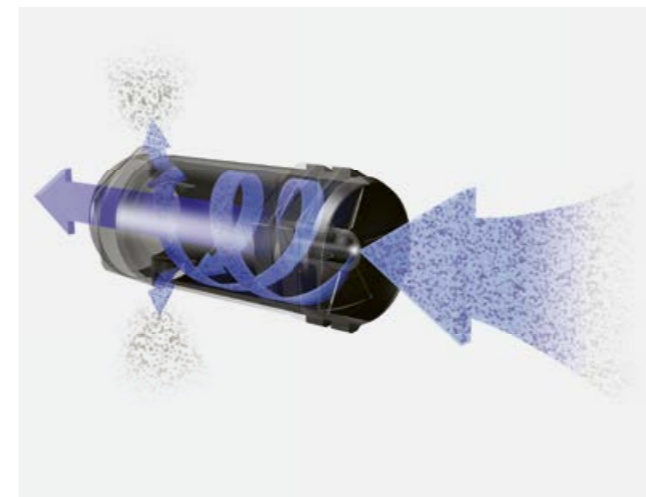

## Cleaning up.

The XERION has an efficient, low-maintenance system for cleaning the engine intake air. Cyclones separate out the coarse dirt which is then removed by the exhaust system.

The engine air intake filter has high filtration performance and is easy to access for cleaning.

# Whatever it takes. CLAAS Service & Parts.



CLAAS Service & Parts  
is there for you 24/7.  
[service.claas.com](http://service.claas.com)

Scan me.



### Safeguard your machine's reliability.

Increase your operating reliability, minimise the risk of breakdown and repair. MAXI CARE offers you predictable costs. Create your own individual service package to meet your particular requirements.



### Specially matched to your machine.

Precision-manufactured parts, high-quality consumables and useful accessories. Choose our comprehensive product range to be certain of receiving exactly the right solution to ensure 100% operating reliability for your machine.



### Global supply.

The CLAAS Parts Logistics Center in Hamm, Germany, stocks almost 200,000 different parts and has a warehouse area of over 183,000 m<sup>2</sup>. This central spare parts warehouse delivers all ORIGINAL parts quickly and reliably all over the world. This means that your local CLAAS partner can supply the right solution for your harvest or your business within a very short time.

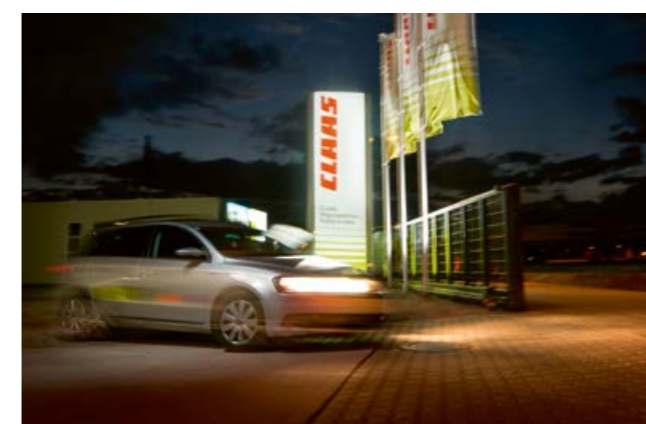

### Your local CLAAS distributor.

Wherever you are, you can count on us to always provide you with the service and the contact people you need. Your CLAAS partners are on hand in your local area, ready to support you and your machine around the clock. With know-how, experience, commitment and the best technical equipment. Whatever it takes.



### Remote Service.

With Remote Service, all the relevant data from your telematics-equipped machines are made available to your service partner. This greatly simplifies the remote diagnostic process and the provision of remote support. Servicing can be carried out more efficiently and the level of machine readiness for use is enhanced. Remote Service is provided to you free of charge for a period of five years. All you have to do is give your consent.



- 1 Perkins 6-cylinder engine, max. 431-524 hp<sup>1</sup>
- 2 One-piece bonnet
- 3 Hydraulic reversible fan
- 4 1000 l fuel tank capacity
- 5 Continuously variable transmission, max. 40 km/h in both directions
- 6 The TRAC concept
- 7 Tyres with max. cross-section of 2.15 m
- 8 Up to ten double-acting spool valves (max. three at the front and max. seven at the rear)
- 9 Up to three double-acting auxiliary spool valves  
Front linkage with height / depth control
- 10 Rear PTO 1000 rpm with reduced engine speed (1730 rpm)
- 11 Armrest with CMOTION multifunction control lever

<sup>1</sup> Compliant with ECE R 120

# Outstanding features.



## CPS.

- Continuously variable transmission over 500 hp
- Efficient, high-performance drive train
- 40 km/h for rapid transfer between fields
- Fully roadworthy in all European countries
- Four equal-sized tyres up to 2.16 m in diameter (710 and 900 series) for perfect traction
- 1000 rpm at the PTO at just 1730 engine rpm
- 2¼" PTO stub for efficient power transfer
- Robust front linkage with continuous 8.1 t lift capacity
- Full output potential at low engine speeds

## Comfort and convenience.

- Wealth of options for optimum customisation, including the rotating cab
- Ergonomic operating concept with innovative CMOTION multifunction control lever
- Easy-to-adjust ballasting for optimal vehicle use

## Operator assistance systems and documentation.

- TELEMATICS for professional documentation and service monitoring
- CLAAS API for transferring data to your farm management system wirelessly
- GPS PILOT with S10 touchscreen terminal
- CSM headland management

XERION		5000	4500	4000
<b>Engine</b>				
Engine		Perkins	Perkins	Perkins
Cubic capacity	cm <sup>3</sup>	12500	12500	12500
Nominal engine speed	rpm	2000	2000	2000
Lower engine idling speed	rpm	800	800	800
Upper engine idling speed	rpm	2080	2080	2080
Rated output (ECE R 120) <sup>1</sup>	kW/hp	358/487 at 2000 rpm	330/449 at 2000 rpm	295/401 at 2000 rpm
Max. output (ECE R 120) <sup>1</sup>	kW/hp	385/524 at 1800 rpm	355/483 at 1800 rpm	317/431 at 2000 rpm
Max. torque (ECE R 120) <sup>1</sup>	Nm	2353 at 1400 rpm	2203 at 1400 rpm	1932 at 1800 rpm
Fuel tank capacity	l	1000	1000	1000

<b>Electrical system</b>				
AC generator	A/V	100 / 24 + 135 / 12	100 / 24 + 135 / 12	100 / 24 + 135 / 12
Batteries	Ah/V	3 x 100 Ah, total 200 / 24, 100 / 12	3 x 100 Ah, total 100 / 24, 100 / 12	3 x 100 Ah, total 100 / 24, 100 / 12

<b>Transmission</b>				
Transmission		Eccom 5.0	Eccom 5.0	Eccom 5.0
Transmission type		Hydrostatic-mechanical split-power	Hydrostatic-mechanical split-power	Hydrostatic-mechanical split-power
Output		Permanent all-wheel drive	Permanent all-wheel drive	Permanent all-wheel drive
Longitudinal differential		100% lockable, lamella construction	100% lockable, lamella construction	100% lockable, lamella construction

<b>Powered steering axles</b>				
Differential lock		100% lockable, electrohydraulic actuation, lamella construction, with automatic function	100% lockable, electrohydraulic actuation, lamella construction, with automatic function	100% lockable, electrohydraulic actuation, lamella construction, with automatic function

<b>Brakes</b>				
Service brake		Hydraulically actuated wet multi-disc brakes, auxiliary-power-reinforced, acting on all wheels	Hydraulically actuated wet multi-disc brakes, auxiliary-power-reinforced, acting on all wheels	Hydraulically actuated wet multi-disc brakes, auxiliary-power-reinforced, acting on all wheels
Parking brake		Electrohydraulically released spring-loaded brake	Electrohydraulically released spring-loaded brake	Electrohydraulically released spring-loaded brake

<b>Hydraulic system</b>				
Max. hydraulic tank capacity	l	120	120	120
Max. drawable volume	l	80	80	80

<sup>1</sup> Identical to ISO TR 14396

XERION		5000 / 4500 / 4000
<b>Main circuit (linkage, spool valves)</b>		
Max. operating pressure	Mpa (bar)	20 (200)
Max. flow rate	l/min	205
Number of spool valves		max. 7 rear, max. 3 front
Max. flow rate per disc	l/min	105
Max. hydraulic output, total	kW	61

<b>Hitch type</b>		
Automatic hitch, D38 pin, spherical	kg	Drawbar load 2500
Hitch with hitch ball, ball system 80	kg	Drawbar load 3000
D40, D50 variable drawbar + Piton Fix	kg	Drawbar load 3000
Drawbar with ball system 80 + Piton Fix	kg	Drawbar load 4000
Hitch ball, 110 mm	kg	Drawbar load max. 15000

<b>Front linkage</b>		
Category		III N, double-acting
Continuous lift capacity / max. lift capacity / max. lift range	mm	81 kN / 84 kN / 905
Selectable function		Raise, lower (press)
Control function		Position control, vibration damping

<b>Rear linkage</b>		
Category		IV N, double-acting
Continuous lift capacity / max. lift capacity / max. lift range	mm	100 kN / 136 kN / 763
Selectable function		Raise, lower (press)
Control function		Position control/draught resistance, vibration damping

<b>Dimensions and weights</b>		
Overall length including linkages	mm	7270
Overall width	mm	mind. 2540 to 3300
Overall height depending on tyres	mm	3651 to 3801
Wheelbase	mm	3500
Ground clearance depending on equipment	mm	375 to 525
Smallest turning circle	m	15
Tare weight (full fuel tank, with driver)	kg	up to 17230

CLAAS continually develops its products to meet customer requirements. This means that all products are subject to change without notice. All descriptions and specifications in this brochure should be considered approximate and may include optional equipment that is not part of the standard specifications. This brochure is designed for worldwide use. Please refer to your nearest CLAAS dealer and their price list for local specification details. Some protective panels may have been removed for photographic purposes in order to present the function clearly. To avoid any risk of danger, never remove these protective panels yourself. In this respect, please refer to the relevant instructions in the operator's manual. All technical specifications relating to engines are based on the European emission regulation standards: Stage. Any reference to the Tier standards in this document is intended solely for information purposes and ease of understanding. It does not imply approval for regions in which emissions are regulated by Tier.



Fit for the road.



CLAAS KGaA mbH  
Mühlenwinkel 1  
33428 Harsewinkel  
Deutschland  
Tel. +49 5247 12-0  
claas.com

LRC / 302012001122 KK LC 1222 / 00 0259 879 6